

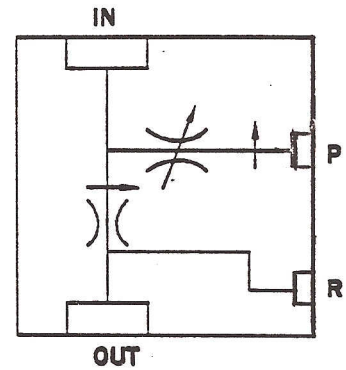

**FLOW
CONTROLS**
PRIORITY TYPE

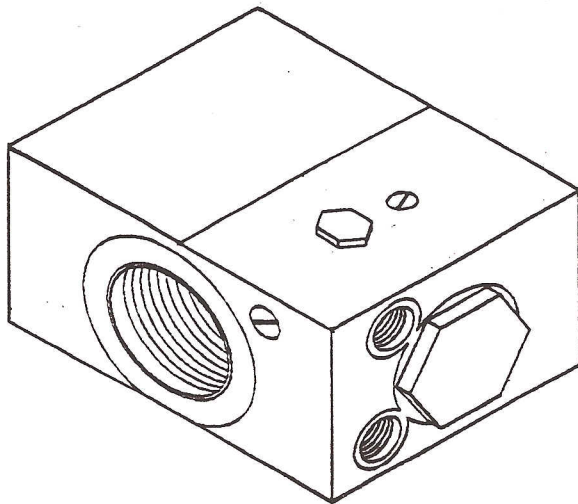

SPECIFICATIONS:

FLOW: 40 GPM MAX. INPUT
PRIORITY FLOW: 0 TO 10 GPM
MAX. PRESSURE: 3000 PSI
SEALS: BUNA "N" STANDARD
MOUNTING: UNRESTRICTED
WEIGHT: 3.75 lbs. (APPROX.)

PERFORMANCE DATA (TYPICAL)

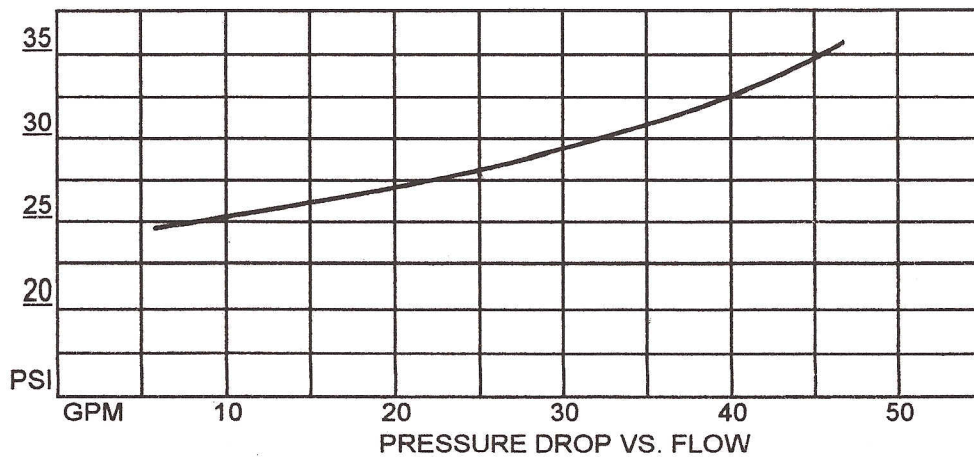

FC-20
4/95

DIMENSIONAL DATA

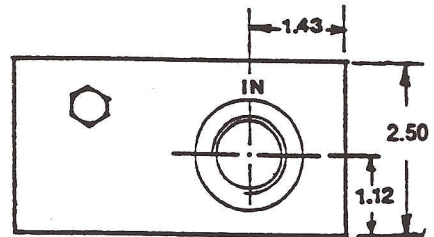
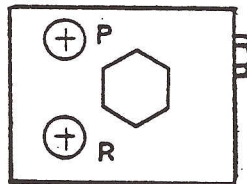
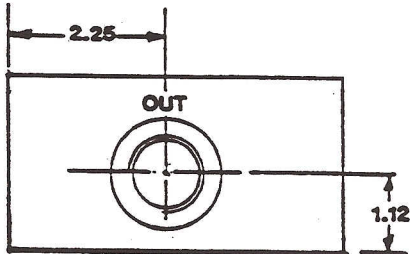
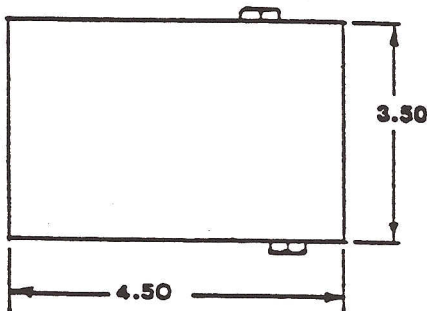

ORDERING INFORMATION

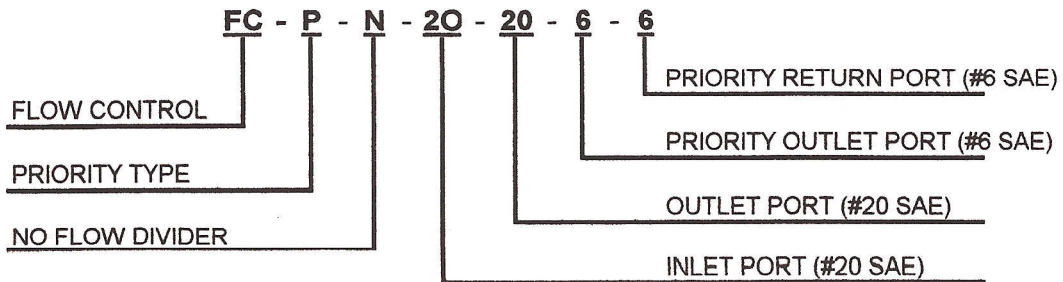

BRANNON HYDRAULICS, INC. P.O. BOX 602 RACINE, WI. 53401-0602
 PHONE (262) 637-8502 FAX (262) 637-8582